

WENSHING®

Wireless Data Radio Modem

(RS485、TTL)

922~928MHz 500mW Multi-point Transceiver

Model: RD232-H-RS485-925M
(RS485 Interface)



Model: RD232-H-TTL-925M
(TTL Interface)



Version History

Version	Date	Changes
V1.01	Sep.21, 2018	1 st . Edition

Content

Important Event	3
➤ Warranty.....	3
➤ Un-warranty Scope Description.....	3
➤ Contact Us.....	3
Key Feature	4
Application	4
Electrical Characteristic	4
Block Diagram	5
Dimension	6
Pin Assignment	7
Installation instructions	8
Instruction Mode	13
➤ Into Set-Up Mode.....	13
➤ Exit Code Mode.....	13
➤ Read In Product Name And Model.....	13
➤ Recover Parameter.....	13
➤ Read In Inside Parameter.....	13
➤ Set Inside Parameter.....	13
➤ Frequency Setting.....	17

Important Event

- This product is in general use for the equipment on the premise of the development, design, manufacture. Do not use that require high security purposes, such as machinery or medical, aviation equipment, machinery and transport-related deaths are directly or indirectly related to the system.
- This product should be in this brochure by the instructions of the types and rated voltage power under the current proper use. If violation of this statement by the safety records of the supply operation, I am afraid our company cannot afford any of the responsibility.
- Do not self-decomposition, alteration, repair of the products also will cause fire, electric shock, fault, and dangerous. In addition, their decomposition, alteration, repair the product, failure is not within the scope of warranty.
- The products are not waterproof, so please do not use and touch water. Take off and on also please note. Rain, spray, drinks, steam, sweat may be a failure.
- Use of this product, please be sure to use according to the statement recorded by the use of methods to operate. Please do not violate particular attention to the matter reminded to use.
- Please respect this statement recorded by the note. When consumers in contravention of this statement recorded note of the operation, I am afraid our company could not shoulder any responsibility.
- Products are defective, the Company will be responsible for free to amend the flaws, or to the same flawless product or its equivalent products in exchange. However, the Company does not assume based on the requirements of the flaw and loss responsibility.
- The Company reserves the right to retain without notice to users of the cases, the product of hardware / software (version upgrade) is with the right to edit.

Warranty

The periods of warranty are within one year from purchased date. The warranty scope is used in normal situation and none vandalism. (Some function harmful out of warranty scope and Vandalism are Un-warranty).

Un-warranty Scope Description

- Because the natural disaster, accident or human factor to cause the bad damage.
- Violate the product instruction manual to cause the damage of the products.
- The improper assemble causes damage.
- The products used the unsanctioned accessory to cause damaged.
- Overstep the allowed used environment to cause the products damaged.

Contact Us

WENSHING ELECTRONICS CO., LTD.

No.82, Chong De St. 11054 Shin Yi Dist., Taipei, Taiwan

Tel: +886-2-27353055

Fax: +886-2-27328813

➤Key Feature

- UHF Band Wireless Data Transceiver
- Frequency Range: 922~928MHz
- RF Output Power: 500mW
- Voltage: 7~24V
- Sensitivity: -126dBm (2Kbps)
- Interface: USB, RS232, RS485, TTL (Optional)
- Transceiver Data Rate: 1.6Kbps~128Kbps

➤Application

- Wireless Network
- Multi-Channel Home Automation
- Wireless RS232
- Active RFID Base Station Transceiver

➤Electrical Characteristic

***7~24V Power Supply.**

Parameter	Min.	Typ.	Max.	Unit	Condition
Operating Condition					
Operating Temperature Range	-10		+70	°C	
Operating Supply Voltage	7		24	V	
Current Consumption					
RX Mode (RS485)		34	40	mA	
TX Mode (RS485)			600	mA	Peak
RX Mode (TTL 3V)		34	40	mA	
TX Mode (TTL 3V)			600	mA	Peak
RF Characteristic					
Frequency Range	922	925	928	MHz	
Data Rate	1.6		128	Kbps	GFSK
TX Output Power		27	27.5	dBm	
RX Sensitivity		-126	-125	dBm	
Modulation		GFSK			
Other					
ESD			2000	V	
Interface Data Rate	1.2		115.2	Kbps	

➤Block Diagram

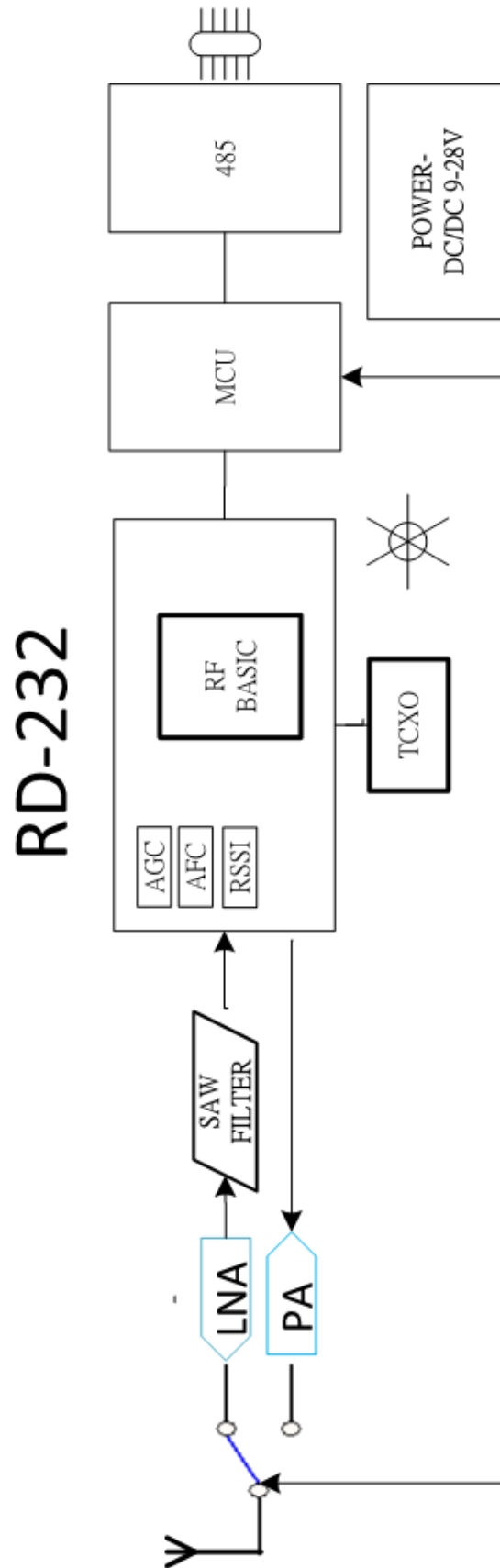

➤Dimension

(Unit : mm)

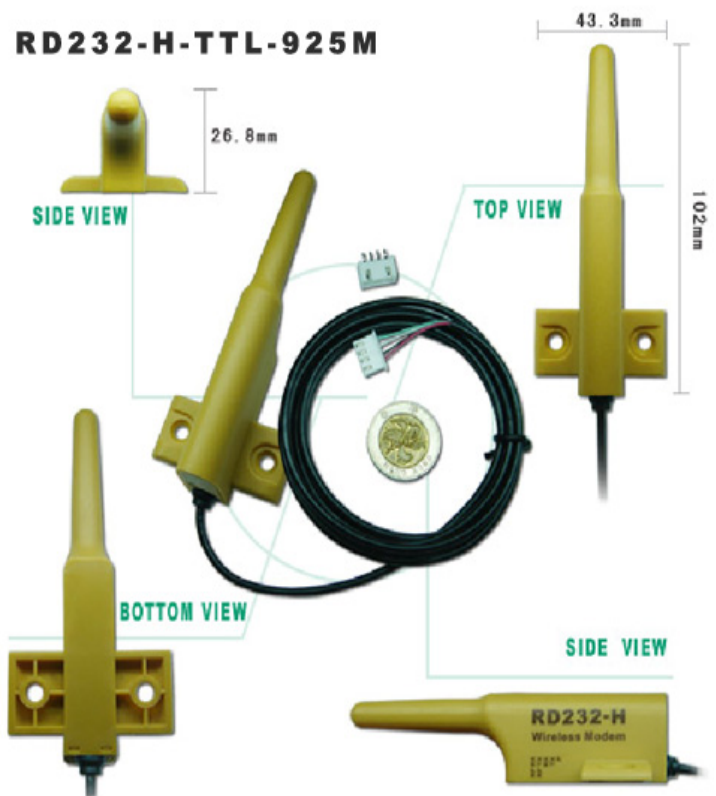
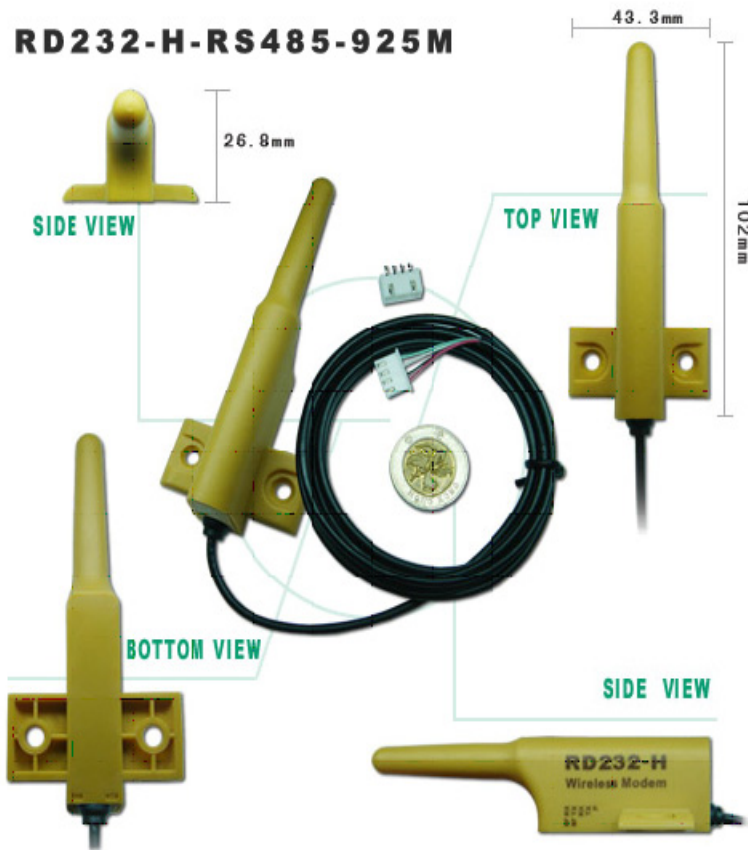

➤ Pin Assignment

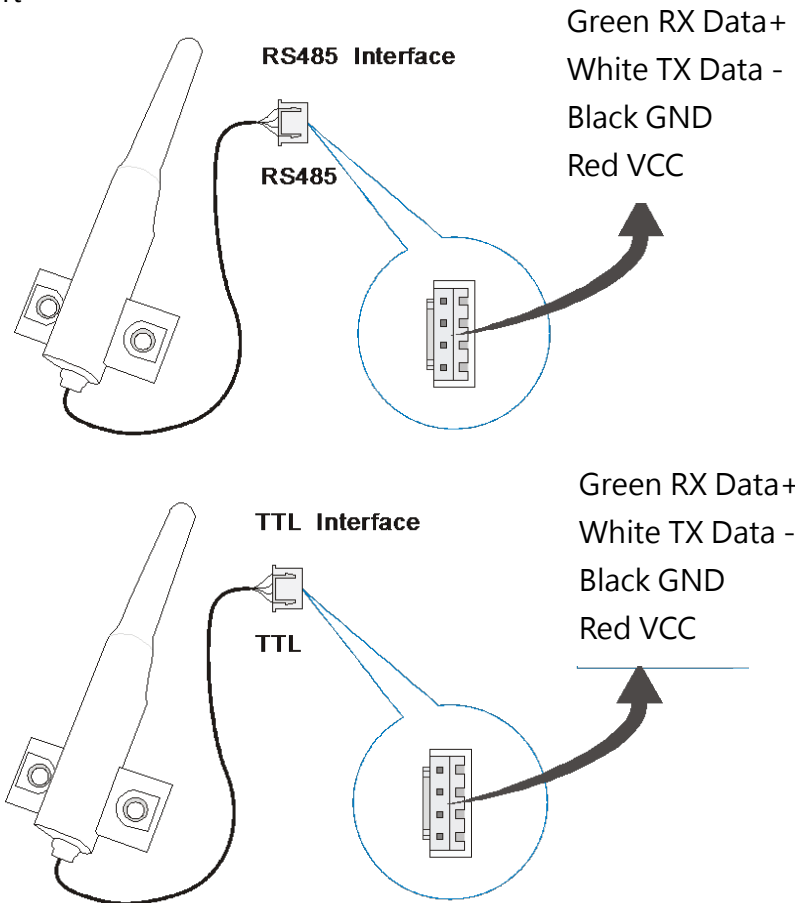

➤ Aperture and spacing

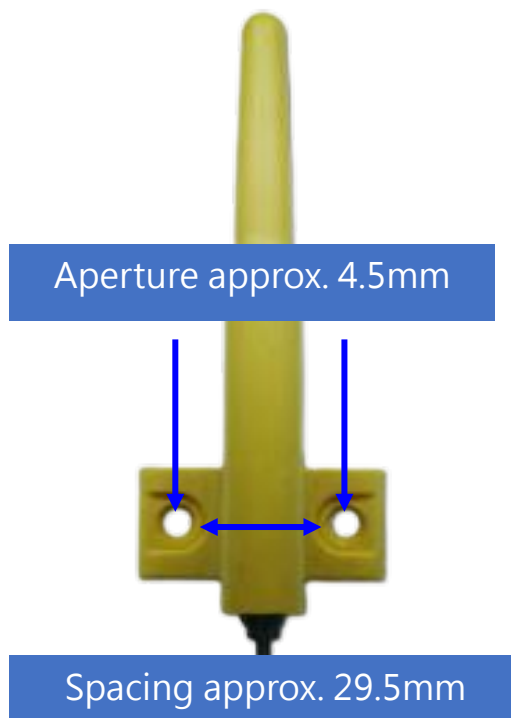

➤ Installation instructions

- Click on the “Software” 、 “Application software” button on the product information page to begin downloading product drivers.

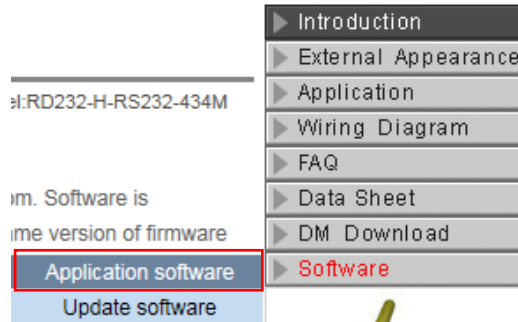

- Decompress the “Product driver” archive.



- After decompression, find the “Windows Server” archive, double click to find the 32-bit or 64-bit system installation .exe file.

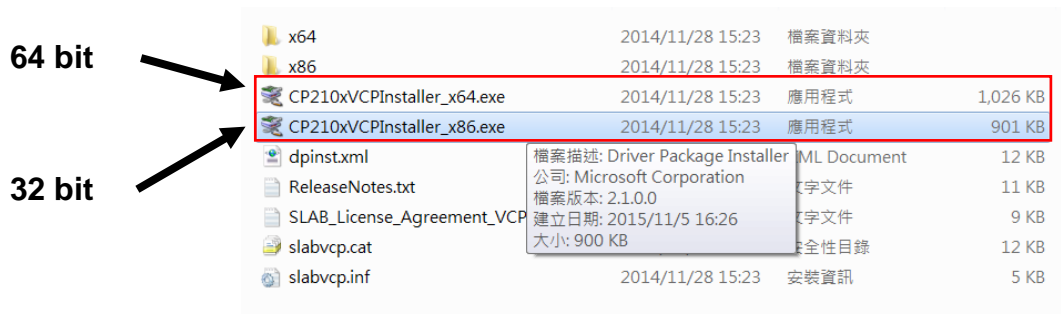
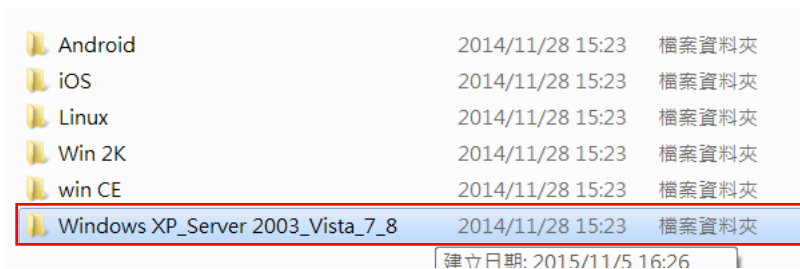

- Left click on “Next”

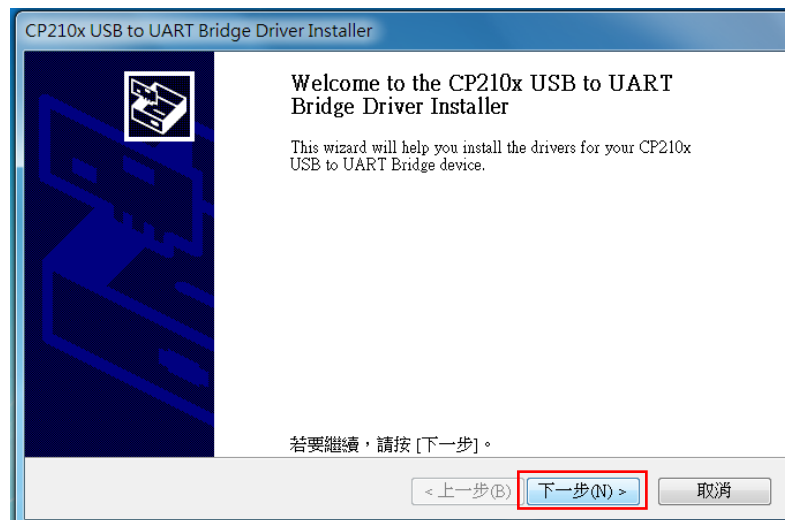

- Check on “I agree this contract” , and left click on “Next” to continue.



- Right click on “Finish” to complete and quit.

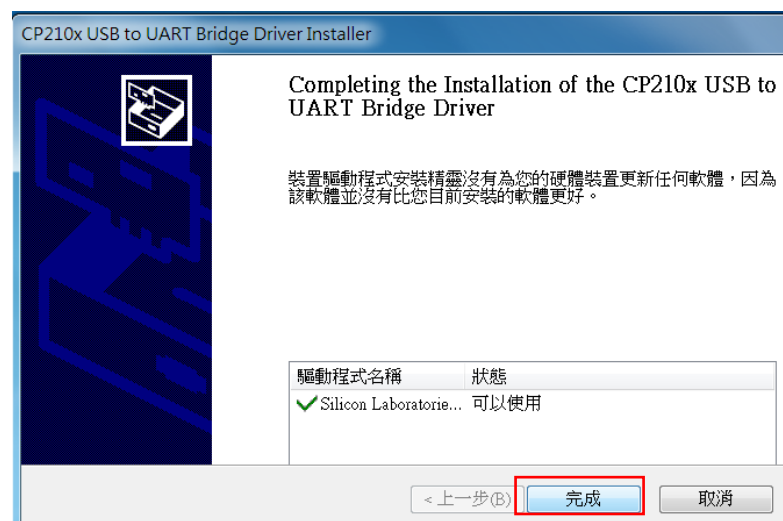

- Open Computer A, insert RD232-H-USB into the USB hub **1**, then open the software's archive, find and double click on the "Test" file **2**, then find and click on the "sscom32.exe." file **3**.



2

Android	2014/11/28 15:23	檔案資料夾
iOS	2014/11/28 15:23	檔案資料夾
Linux	2014/11/28 15:23	檔案資料夾
Test	2015/11/14 13:37	檔案資料夾
Win 2K	2014/11/28 15:23	檔案資料夾
win CE	2014/11/28 15:23	檔案資料夾
Windows XP_Server 2003_Vista_7_8	2014/11/28 15:23	檔案資料夾

3

sscom32.exe	2015/11/5 17:36	應用程式	771 KB
-------------	-----------------	------	--------

- Open the software, choose your "ComNum" (serial number, "COM2" for example) **4**, then choose "9600" **5** for your baud rate, and then click on "Open Com" **6** to complete Computer A's setup.

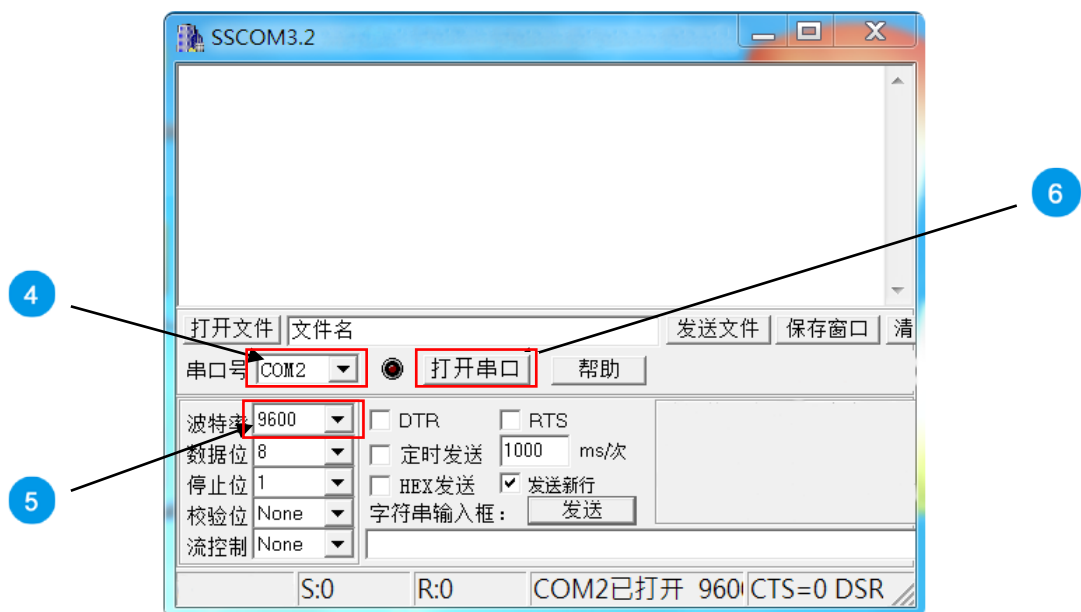

- Insert RD232-H-USB into Computer B' s USB hub **7** . Open the software' s file and find the “Test” file **8** . In the “Test” file, find and double click on “sscom32.exe” **9** .



	B.PC		RD232-H-USB
	Android	2014/11/28 15:23	檔案資料夾
	iOS	2014/11/28 15:23	檔案資料夾
	Linux	2014/11/28 15:23	檔案資料夾
8	Test	2015/11/14 13:37	檔案資料夾
	Win 2K	2014/11/28 15:23	檔案資料夾
	win CE	2014/11/28 15:23	檔案資料夾
	Windows XP_Server 2003_Vista_7_8	2014/11/28 15:23	檔案資料夾
9	sscom32.exe	2015/11/5 17:36	應用程式 771 KB

- Open the software, choose your “ComNum” (serial number, “COM3” for example), **10** then choose “9600” for your baud rate **11**, and then click on “Open Com” **12** to complete Computer B's setup.

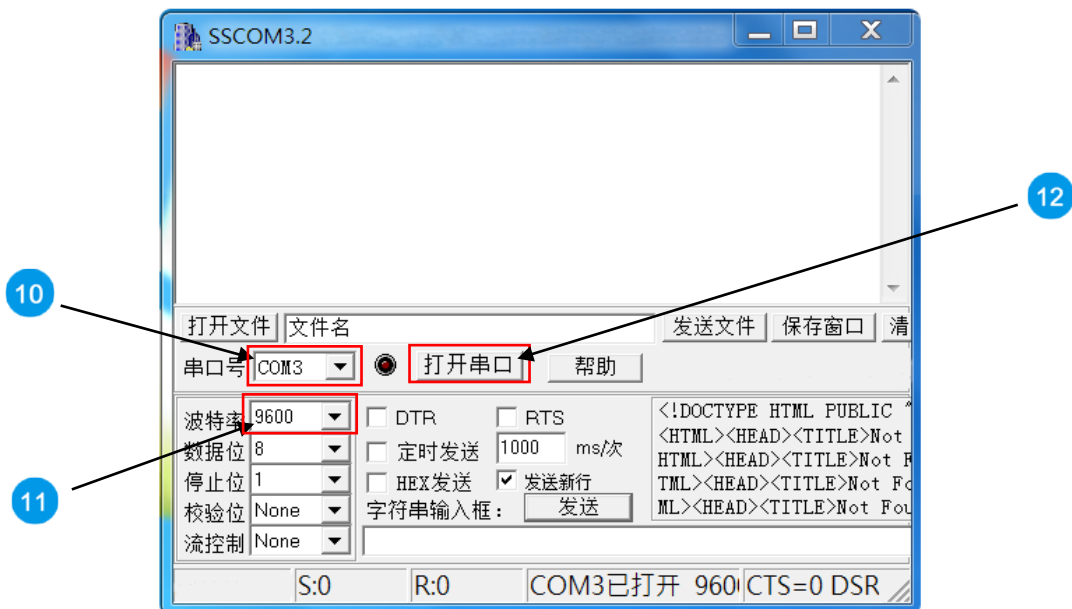

- On Computer A' s screen, type “ABCDEF” ¹³ under the “data input” ¹⁴ column. If pairing successful, you can find the same text on Computer B' s screen ¹⁵ .

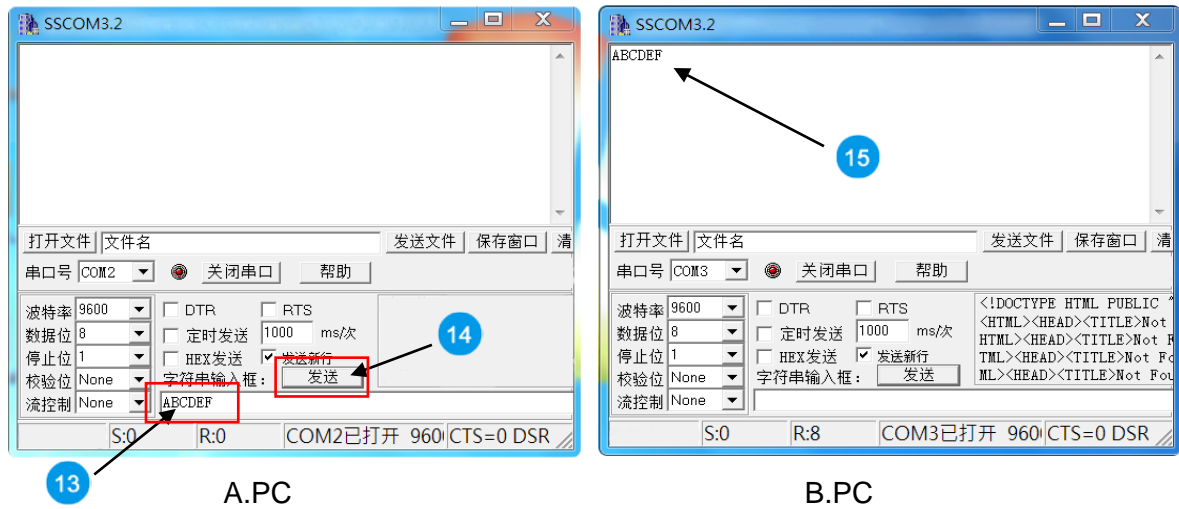

- On Computer B' s screen, type “HIJKLMN” ¹⁶ under the “data input” ¹⁷ column. If pairing successful, you can find the same text on Computer A' s screen ¹⁸ .

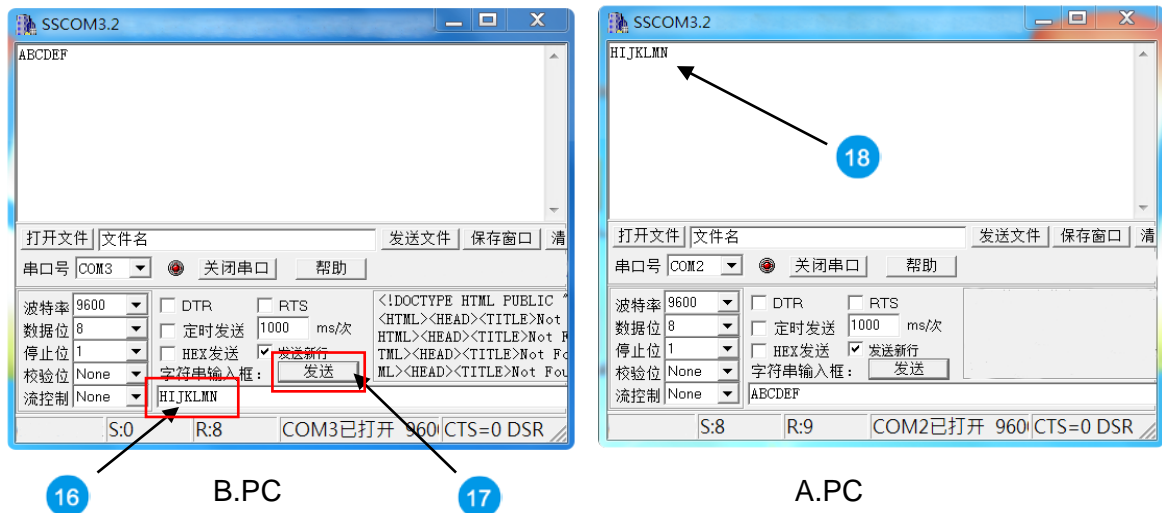

07, the beginning rate is 9600bps.

Bit7: 0~ 8-bit format (8,1,N/7,1,O/7,1,E/7,2,N)

1~ 9-bit format (8,1,O/8,1,E/8,1,S/8,2,N(8,1,M)

Note : N/O/E/M/S mean No check(None) , Odd parity check(Odd) , Even parity check(Even) , 1 check(Mark) , 0 check(Space)

Bit6~5 : 00 None check/Mark check

01 Odd parity check

10 Even parity check

11 Space check

Bit4~3: Fixed to 0

Bit2~0: Interface rate

Value	0	1	2	3	4	5	6	7
Rate(bps)	1200	2400	4800	9600	19.2K	38.4K	57.6K	115.2K

✧ 3rd & 4th Byte: Group (GID) , set up range 0000~FFFF

✧ The 5th Byte: Instrument ID(SID) , set up range 00~FF

✧ The 6th Byte: Wrong parameter, fixed as 0x00

✧ The 7th Byte: Transmit rate, set up range 00~07; Normally, the RF transmit rate must greater than interface speed rate when setting up, it prevents having the wrong information.

Value	0	1	2	3	4	5	6	7
Rate(bps)	1600	3200	6400	12.8K	25.6K	51.2K	76.8K	128K

✧ The 8th to 10th Byte: Working frequency, calculation:

MHz*1000=KHz, and transfer to 16 Bytes.

For example: When it is at 925MHz working frequency ,

925*1000=925000=0x0E 1D 48 fill in 0E in the 8th Byte, fill in 1D in the 9th Byte, fill in 48 in the 10th Byte.

When it is at 924.5MHz working frequency, 924.5*1000=924500=0x0E 1B 54; fill in 0E in the 8th Byte, fill in 1B in the 9th Byte, fill in 54 in the 10th Byte.

✧ The 11th Byte:

Bit0~Bit2: Shooting rate , set up range 0~7

Output Power		
dBm	Set Value	Hex (Bit0~Bit2)
5	0	000
12	1	001

17	2	010
21	3	011
24	4	100
25	5	101
26	6	110
27	7	111

Bit3~Bit5: Wrong parameter , fixed as 000

Bit6~Bit7: Instrument working mode , there are 4 modes:

0 Mode 1 (Long Data mode: Set-up as 00)

GID of every instrument can receive info at this mode, and it can specifically use on data info that is larger than 127 Bytes.

0 Mode 2 (ID Information Mode 1: Set-up as 01)

Once GID can transmit to particular SID instrument under this mode, it is one to many; the single info must \leq 127 Bytes.

0 Transmission: The 1st Byte is the SID of the receiver, and from the 2nd byte, it becomes data.

Example: The SID of device A is 55, the SID of device B is 88, and they have the same GID. Under mode 2, device A is going to transmit data 0x1234567890, 5 Bytes in total, to B device, A then sends data 0x881234567890, 6 Bytes in total to B, B will receive 0x551234567890, 6 Bytes in total. The 1st Byte is the SID of the transmitter.

0 Mode 3 (ID Information Mode 2: Set-up as 10)

Once GID can transmit to particular SID instrument under this mode, it is one to many; the single info must \leq 127Bytes.

Transmission: Data shall be transmitted under the same rule of the 13th to 32nd Byte.

Example: The GID of device A = AAAA, SID = 55; the GID of device B = BBBB, SID = 88; the GID of device C = CCCC, SID = 99.

A is going to transmit 0x1234567890 to B, 5 Bytes in total. A then sends 0x04FFBBBB881234567890, 10 Bytes in total, to B, B will receive 0x1234567890, 5 Bytes in total.

A is going to transmit 0x1234567890, 5 Bytes in total, to B via C. A then sends 0x08FFBBBB88FFCCCC991234567890, 14 Bytes in total, C will receive 0x1234567890, 5 Bytes in total, but B will not receive any data.

0 Mode 4 (Memory ID Information Mode: Set-up as 11)

It can set in advance to save particular GID and SID way, it will transmit it back referring to the track it is saved. It can forward the track up to 14 times, the single info must ≤ 127 Bytes.

- ✧ The 12th Byte: Wrong parameter, it fixed as 0x00.
- ✧ The 13th to 32nd Byte: The pre-saved track, it only works (saved ID data mode).
- ✧ The 13th Byte: It shows how much information in the 14th to 32nd Byte.
- ✧ The 14th to 32nd Byte routing formation:

◆ Example 1: 04 FF 12 34 55 11 22 33 44~00

From 13th Byte, it can be seen that the effective 4 Bytes data are FF 12 34 55.

FF 12 34 55 represents GID=1234, SID=55. When this equipment receives data via UR, it will automatically transmit the data to GID=1234, SID=55.

◆ Example 2: 05 FF 12 34 55 11 22 33 44~00

From 13th Byte, it can be seen that the effective 5 Bytes data are FF 12 34 55 11.

FF 12 34 55 11 represents GID=1234, SID=55 and 11. When this equipment receives data via UR, it can automatically transmit the data to GID=1234, SID=55 and then forward the data to GID=1234, SID=11.

◆ Example 3: 06 FF 12 34 55 11 22 33 44~00

From 13th Byte, it can be seen that the effective 6 Bytes data are FF 12 34 55 11 22.

FF 12 34 55 11 22 represents GID=1234, SID=55, 11 and 22. When this equipment receives data via UR, it will automatically transmit the data to GID=1234, SID=55, and forward the data to GID=1234, SID=11, and again forward the data to GID=1234, SID=22.

◆ Example 4: 08 FF 12 34 55 FF 45 67 88 44~00

From 13th Byte, it can be seen that the 8 Bytes effective data are FF 12 34 55 FF 45 67 88.

FF 12 34 55 FF 45 67 88 represents GID=1234, SID=55 and GID=4567, SID=88. When this equipment receives the data via UR, it will automatically transmit the data to GID=1234, SID=55, and then forward the data to GID=4567, SID=88.

